



Dokumentace

k dílu č. 2010/03

Internetový a intranetový informační systém pro Ústav chemických procesů AV ČR, v. v. i.

Název a adresa subjektu objednatele:

| | |
|-------------------|--|
| <i>Organizace</i> | Ústav chemických procesů AV ČR, v. v. i. |
| <i>IČ</i> | 67985858 |
| <i>DIČ</i> | CZ67985858 |
| <i>Adresa</i> | Rozvojová 2/135 |
| <i>Obec</i> | 165 02 Praha 6 - Lysolaje |
| <i>Zástupce</i> | Miroslav Fridrich |

Následující informace jsou určeny pro objednatele.

Zpracoval Tomáš Feltl – TFSoft.



Předmět projektu

Vytvoření aktuálního informačního systému s přehledným grafickým rozhraním pro sdílení odborných, popularizačních a administrativních informací, které vznikají přímo na pracovištích ÚCHP i informací z externího prostředí.

Pro vlastní realizaci se smluvní strany dohodnuli na využití open source CMS systému Drupal (www.drupal.org).

Použité technologie

Realizace informačního systému je založena na „open source“ systému (CMS) Drupal (www.drupal.org), který náleží mezi nejlepší systémy svého druhu.

Systém Drupal využívá PHP skriptování na straně serveru a v případě realizace pro ÚCHP databázový stroj MySQL.

Vizuální stránka, včetně rozvržení jednotlivých prvků, je od obsahu striktně oddělena a je řešena s využitím kaskádových stylů (CSS). Tím je kdykoli umožněna snadná změna celkového vzhledu portálu.

Grafický návrh, odsouhlasený objednatelem, je zahrnut v příloze č. 1. Grafické šablony *uchp_theme* a *rootcandy* jsou použitelné ve všech současných nejrozšířenějších internetových prohlížečích (MS IE 8, Firefox 3, Opera 10). V případě starších prohlížečů nemusí být jednotlivé grafické prvky zobrazovány zcela korektně.

Provoz systému

Systém je provozován prostředky objednatele. Pro vývoj a testování byla objednatelem vyčleněna doména new.icpf.cas.cz.

Vlastní požadavky na provoz

Webový server Apache (+ mod_rewrite) s podporou PHP (minimálně verze 5.2+, aktivovaná rozšíření gd2, iconv a mbstring). Databáze MySQL (minimálně verze 5+).

Dále je doporučeno nastavení paměti dostupné pro PHP thread na 128 MB a navýšení hodnoty „maximum uploaded filesize“ alespoň na 16 MB.

Upřesňující informace je možné získat přímo na adrese www.drupal.org/requirements.

Přístup k administracnímu rozhraní

Vstup do administracní části systému/intranetu je možný standardním přihlášením uživatele, a to na adrese new.icpf.cas.cz/user. V systému je vytvořen hlavní administrátorský účet „webmstr“ a řada dalších uživatelských účtů zaměstnanců a případně dalších spolupracujících osob. Vytvoření účtu zaměstnanců probíhá automaticky na základě ověření zadaných přihlašovacích údajů vůči LDAP serveru organizace.

Přednastavený globální administracní účet (superadmin): uživatel „webmstr“ (heslo: *5Pxno0IUcQM*). Vzhledem k tomu, že vyzrazení administrátorských jmen a hesel může vést k záměrnému pozměnění či zničení obsahu vašeho portálu, uchovejte tyto informace na bezpečném místě, nebo si hesla a uživatelská jména dle vlastního uvážení pozměňte!

Více informací ohledně konfigurace a správy systému naleznete v administracní videolekci na přiloženém DVD (struktura DVD viz příloha č. 2).

Aktualizace a zabezpečení

Jako každý softwareový systém ani systém Drupal není bez chyby. Stejně jako provádíte bezpečnostní aktualizace např. u operačního systému, je pro minimalizaci možných bezpečnostních (i funkčních) problémů vhodné provádět také aktualizace systému Drupal a rozšiřujících funkčních modulů (přehled použitých modulů viz příloha č. 3). Před



nasazením aktualizace do skutečného prostředí je nezbytné řádné otestování aktualizace v testovacím prostředí a eliminace možných problémů (např. nekompatibilita aktualizované verze Drupal s použitými funkčními moduly). Moduly, které mají v rámci svého názvu či verze uvedeno „upr“, popř. „tfs“, jsou moduly, které bylo nutno upravit/vytvořit přímo k dosažení požadované funkčnosti (v přehledu použitých modulů jsou pro odlišení podbarveny žlutě, viz příloha č. 3). Takovéto moduly nelze aktualizovat standardní cestou. Pro přístup k administračnímu rozhraní doporučujeme používat zabezpečený protokol (https). Vhodné je použít alespoň jednoduchý *RapidSSL* certifikát, jehož cena se pohybuje kolem 3 tis. Kč/2 roky.

V případě zájmu může být prováděna nepravidelná aktualizace naší firmou. Tato služba je zpoplatněna.

Zálohování:

Důležitá data by měla být pravidelně zálohována! Nespolehejte pouze na to, že záloha vašeho portálu probíhá např. automaticky na straně poskytovatele hostingových služeb. Zajistěte si pravidelné zálohování!

Vlastní uživatelská záloha obsahu internetové prezentace představuje zálohu **databáze** (*databáze je zálohována také vlastním systémem automaticky pomocí modulu „Backup and Migrate“ s intervalem 1 měsíce, zachovaná hloubka historie záloh je 20; v průběhu testování byla databáze zálohována s četností jednoho dne se zachovanou historií 120 záloh*), dále zálohu obsahu **adresářové struktury systému Drupal** a zálohu **adresářové struktury uživatelských dat** (*uživatelské soubory jsou zálohovány vlastním systémem automaticky pomocí modulu „Backup and Migrate“ s intervalem 1 měsíce, zachovaná hloubka historie záloh je 6*).

Záloha databáze může být realizovaná také přes internetové rozhraní (např. pomocí phpMyAdmin). K zálohování souborů je vhodné využít přístup pomocí FTP klienta.

Protože je systém provozován vašimi vlastními prostředky, přístupové údaje k MySQL databázi a FTP serveru obdržíte od vašeho IT správce. Doporučujeme přenechat kompletní nastavení a zabezpečení zálohování, včetně redundance na serverové úrovni, vašemu IT správci.

Ověřte si, zda je zálohováno vše potřebné! V případě poruchy na serveru, kde je systém umístěn, může dojít k poškození/ztrátě aktuální verze vašich dat!

V případě zájmu může být prováděna pravidelná kompletní záloha naší firmou. Tato služba je zpoplatněna v závislosti na požadované četnosti (každý den, týdně, měsíčně, čtvrtletně).



Struktura a administrace systému:

- Základní schéma struktury a vzájemných vztahů částí systému je uvedeno v příloze č. 4.
- V systému je definována řada specifických datových struktur, jejichž schematický popis je v příloze č. 5.
- K zabezpečení funkčnosti je použita řada funkčních modulů, jejichž seznam je v příloze č. 3. *(Některé funkce byly vyvinuty/upraveny speciálně po potřeby objednatele.)* Vzhledem k rozsahu je v tištěné dokumentaci zahrnut pouze seznam modulů. Ostatní informace jsou k dispozici v elektronické verzi na DVD (soubor „TFSoft - Konfigurace systému a Seznam modulu - ICPF.pdf“)
- Základní administrační a konfigurační úkony jsou popsány formou videolekcí, které jsou v systému k dispozici on-line (přiloženy jsou také na DVD, struktura DVD viz příloha č. 2). *(Další typické administrační úkony byly probrány v rámci zaškolení pracovníků organizace.)*

Příloha č. 1

Schválený grafický návrh

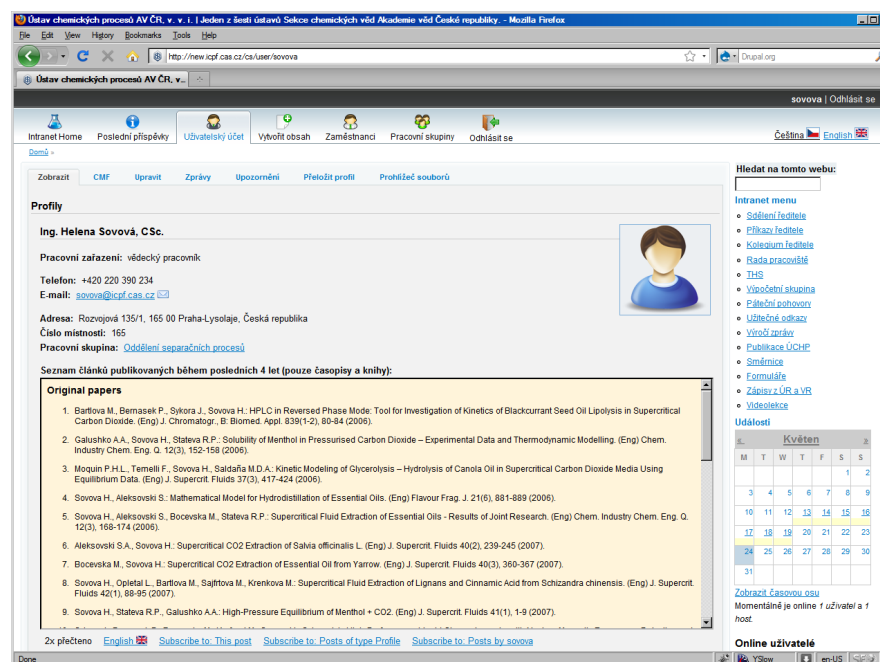

Značné procento mužů trpí některou z poruch vnímání barev. Proto je důležité vědět, jak asi budou tyto lidé vaše stránky vnímat. Komplexní informace o jednotlivých typech poruch vnímání barev naleznete například na stránce http://en.wikipedia.org/wiki/Color_blindness.

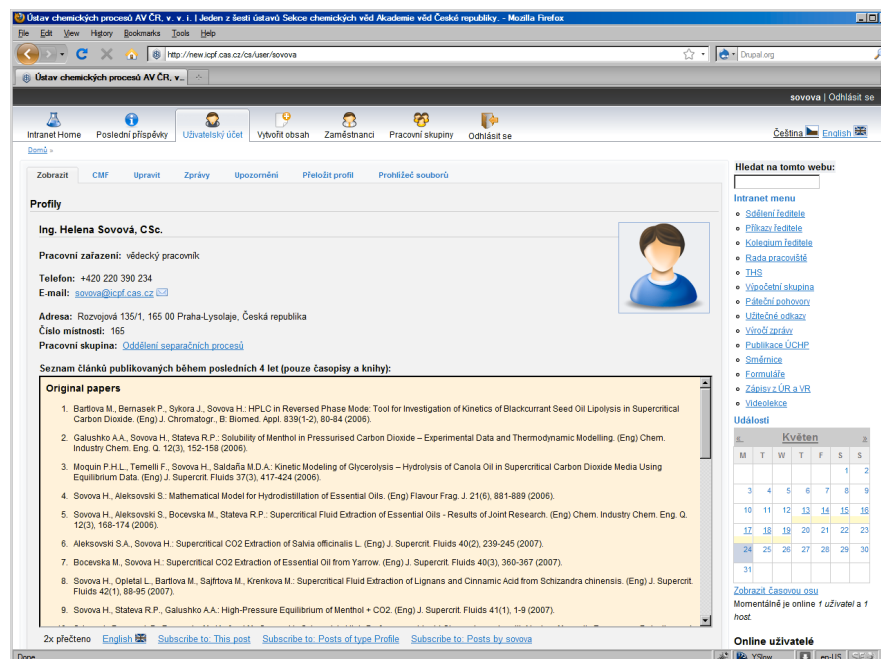

Simulace vady vnímání barev - protanopie

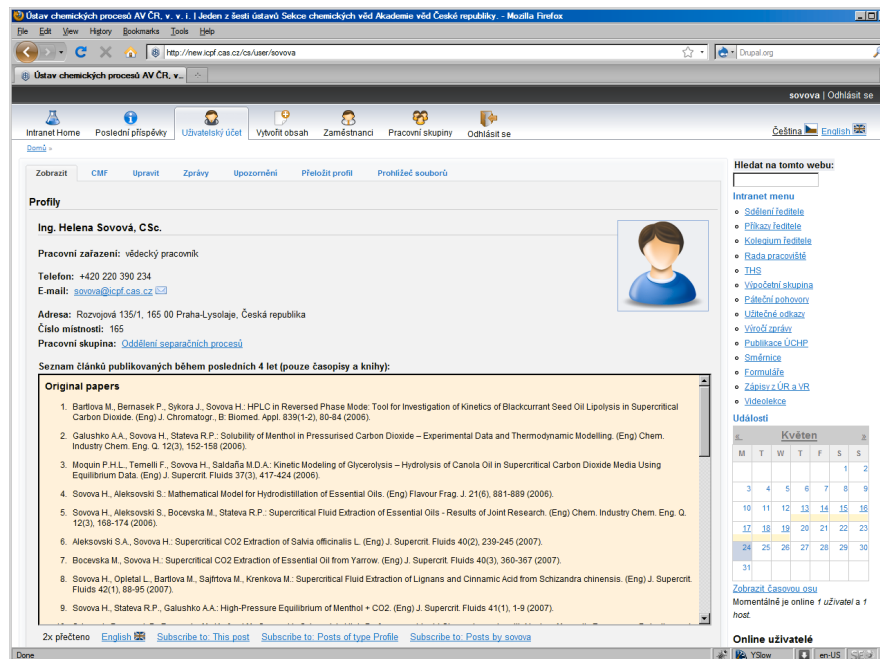

Simulace vady vnímání barev - deuteranopie (nejčtenější)

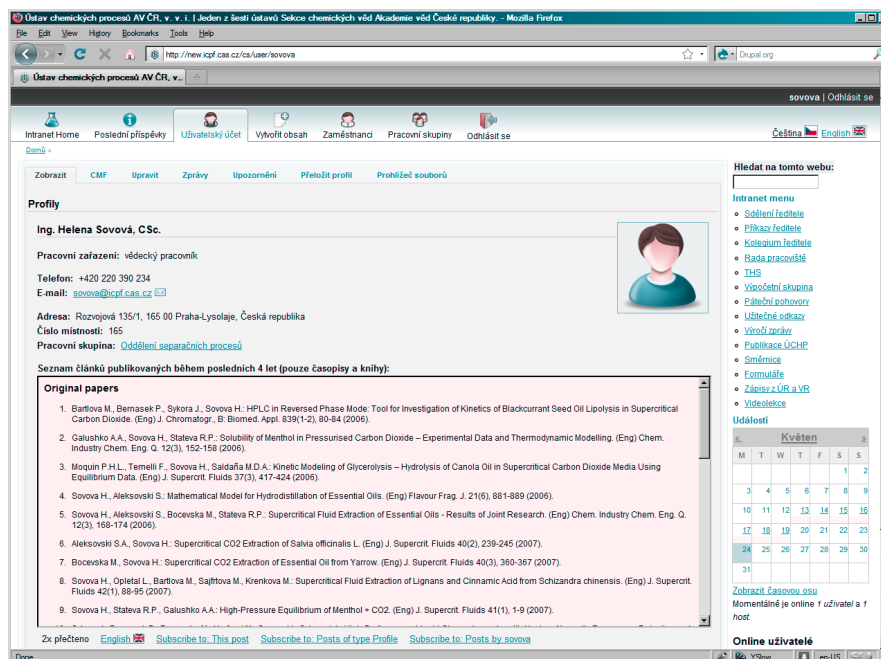

Simulace vady vnímání barev - tritanopie

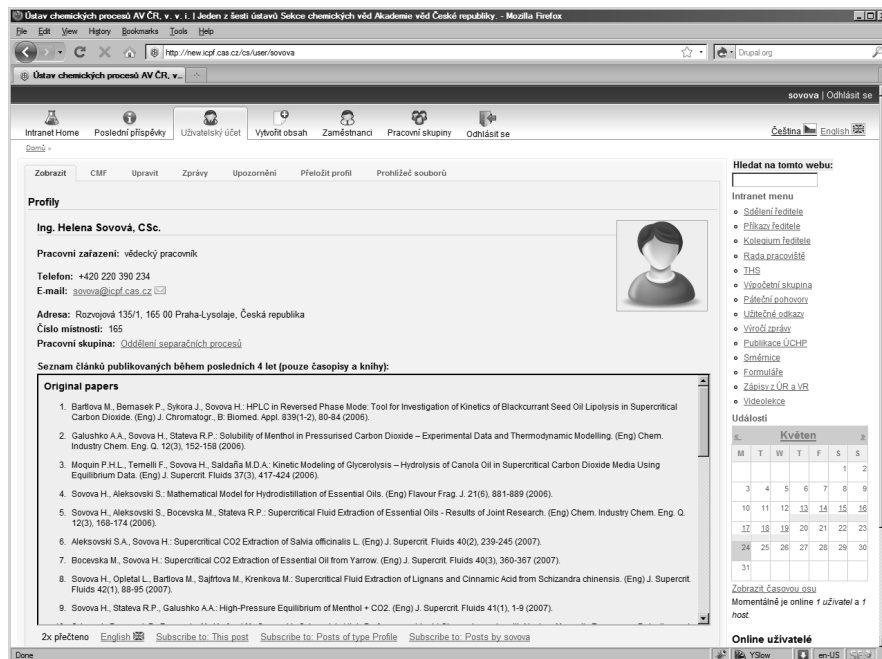

Simulace vady vnímání barev - achromatopsie (úplná barvoslepost)

Příloha č. 2

Obsah přiloženého DVD média

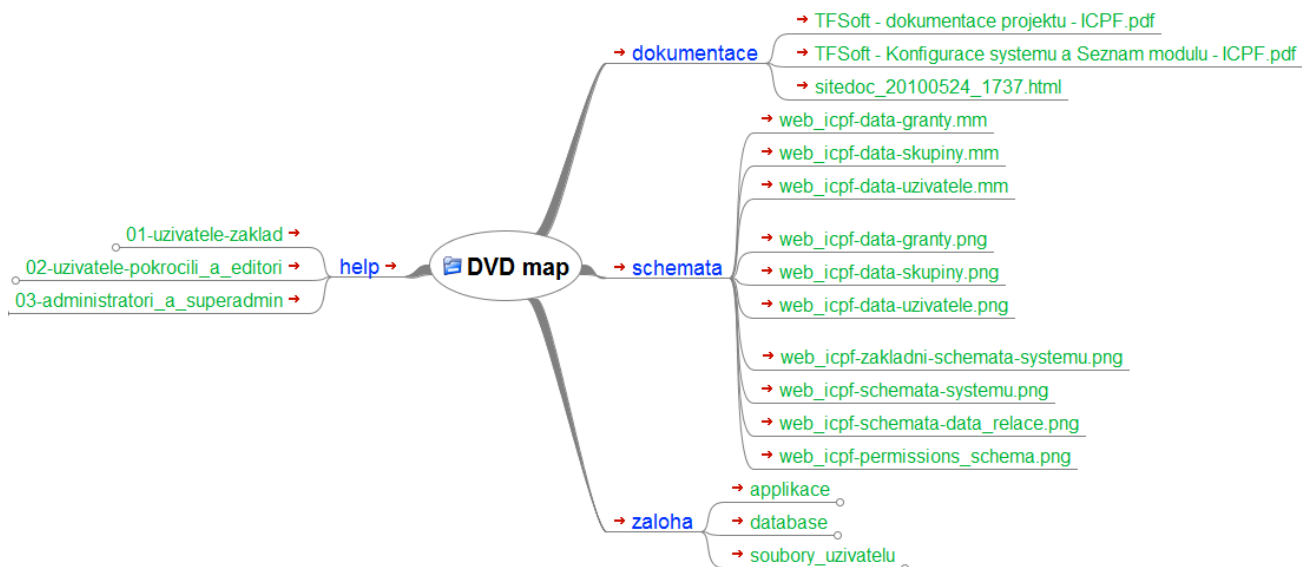

Příloha č. 3

Seznam použitých modulů (žlutě označeny moduly upravené nebo vytvořené k dosažení požadované funkčnosti)

Modules

Access control

| Name | Version | Status | Project / Package | Description | Required By | Depends On |
|---------------|---------|---------|---|---|---|---------------------|
| Module Grants | 6.x-3.5 | Enabled | Module_grants Access control sites/default/modules/ | Enables access control for unpublished content and allows modules that operate on access grants to work together in the expected way. | | Node Tools(enabled) |
| Node Tools | 6.x-3.5 | Enabled | Module_grants Access control sites/default/modules/module_grants/ | API with generic reusable functions for node objects. | module_grants, module_grants_monitor | |

Administration

| Name | Version | Status | Project / Package | Description | Required By | Depends On |
|---------------------------|-------------|---------|---|--|------------------------|--|
| Administration menu | 6.x-1.5 | Enabled | Admin_menu Administration sites/default/modules/ | Provides a dropdown menu to most administrative tasks and other common destinations (to users with the proper permissions). | admin_menu_dropdown | |
| Cache browser | 6.x-1.4 | Enabled | Cache_browser Administration sites/default/modules/ | Browse, dump and reset the content of Drupal cache tables. For developers, function cbdump(\$mixed [,\$varname]) is provided as an alternative to var_dump() for debugging purposes. | | Format Number API(enabled) |
| Content management filter | 6.x-2.x-dev | Enabled | Cmf Administration sites/default/modules/ | This module adds an easier way for administrators to filter the content on a Drupal site for administration purposes. | | |
| Total Control | 6.x-1.2 | Enabled | Total_control Administration sites/default/modules/ | Total Control Administration Dashboard | total_control_workflow | Panels(enabled), Views content panes(enabled), Page manager(enabled), Views Bulk Operations(enabled), Chaos tools(enabled), Views(enabled) |

CCK

| Name | Version | Status | Project / Package | Description | Required By | Depends On |
|---------------------|---------|---------|--|--|--|--|
| Content | 6.x-2.6 | Enabled | Cck CCK sites/default/modules/ | Allows administrators to define new content types. | content_copy, content_permissions, content_profile_tokens, content_taxonomy, content_taxonomy_autocomplete, content_taxonomy_options, content_taxonomy_tree, date, date_tools, email, fieldgroup, i18ncck, iframe, image_fupload_imagefield, imcofile, imcoimage, int_meta_cck, link, nodereference, number, optionwidgets, phone, text, userreference, viewreference, multiselect | |
| Content Copy | 6.x-2.6 | Enabled | Cck CCK sites/default/modules/cck/modules/ | Enables ability to import/export field definitions. | | Content(enabled) |
| Content Permissions | 6.x-2.6 | Enabled | Cck CCK sites/default/modules/cck/modules/ | Set field-level permissions for CCK fields. | | Content(enabled) |
| Fieldgroup | 6.x-2.6 | Enabled | Cck CCK sites/default/modules/cck/modules/ | Create display groups for CCK fields. | | Content(enabled) |
| Node Reference | 6.x-2.6 | Enabled | Cck CCK sites/default/modules/cck/modules/ | Defines a field type for referencing one node from another. | | Content(enabled), Text(enabled), Option Widgets(enabled) |
| Number | 6.x-2.6 | Enabled | Cck CCK sites/default/modules/cck/modules/ | Defines numeric field types. | | Content(enabled) |
| Option Widgets | 6.x-2.6 | Enabled | Cck CCK sites/default/modules/cck/modules/ | Defines selection, check box and radio button widgets for text and numeric fields. | content_taxonomy_options, multiselect, nodereference, userreference | Content(enabled) |
| Text | 6.x-2.6 | Enabled | Cck CCK sites/default/modules/cck/modules/ | Defines simple text field types. | nodereference, userreference, viewreference | Content(enabled) |
| User Reference | 6.x-2.6 | Enabled | Cck | Defines a field type for | | Content(enabled), |

| | | | | | | |
|-------------------------------|---------------|---------|---|---|--|---|
| | | | CCK sites/default/modules/cck/modules/ | referencing a user from a node. | | Text(enabled), Option Widgets(enabled) |
| Content Templates | 6.x-1.1 | Enabled | Contemplate CCK sites/default/modules/ | Create templates to customize output of teaser and body content. | | |
| Content Taxonomy | 6.x-1.0-rc2 | Enabled | Content_taxonomy CCK sites/default/modules/ | Defines a field type for taxonomy terms | content_taxonomy_autocomplete, content_taxonomy_options, content_taxonomy_tree | Content(enabled), Taxonomy(enabled) |
| Content Taxonomy Autocomplete | 6.x-1.0-rc2 | Enabled | Content_taxonomy CCK sites/default/modules/ | Defines an autocomplete widget type for content_taxonomy | | Content(enabled), Content Taxonomy(enabled), Taxonomy(enabled) |
| Content Taxonomy Options | 6.x-1.0-rc2 | Enabled | Content_taxonomy CCK sites/default/modules/ | Defines an option widget type for content_taxonomy for selects, radios/checkboxes | | Content(enabled), Content Taxonomy(enabled), Taxonomy(enabled), Option Widgets(enabled) |
| Email | 6.x-1.2 | Enabled | Email CCK sites/default/modules/ | Defines an email field type for cck | | Content(enabled) |
| Iframe | 6.x-1.5 | Enabled | Iframe CCK sites/default/modules/ | Defines simple iframe field types as CCK submodule. | | Content(enabled) |
| IMCE File | 6.x-1.x-dev | Enabled | Imcefile CCK sites/default/modules/ | Defines an IMCE file field type. | | IMCE(enabled), Content(enabled) |
| IMCE Image | 6.x-1.0-beta2 | Enabled | Imceimage CCK sites/default/modules/ | Defines an IMCE image field type. | | IMCE(enabled), Content(enabled) |
| Link | 6.x-2.8 | Enabled | Link CCK sites/default/modules/ | Defines simple link field types. | | Content(enabled) |
| Multiselect | 6.x-1.6 | Enabled | Multiselect CCK sites/default/modules/ | Defines a CCK multiple selection field widget, to allow easier multi-selection for users. | | Option Widgets(enabled), Content(enabled) |
| Phone - CCK | 6.x-2.14 | Enabled | Phone CCK sites/default/modules/ | The phone module allows administrators to define a CCK field type for phone numbers. | | Content(enabled) |
| View Reference | 6.x-2.24 | Enabled | Viewreference CCK sites/default/modules/ | Defines a field type for referencing a view from a node. | | Content(enabled), Text(enabled), Views(enabled) |

Chaos tool suite

| Name | Version | Status | Project / Package | Description | Required By | Depends On |
|---------------------|-------------|---------|---|--|--|--------------------------------------|
| Chaos tools | 6.x-1.x-dev | Enabled | Ctools Chaos tool suite sites/default/modules/ | A library of helpful tools by Merlin of Chaos. | bulk_export, ctools_plugin_example, page_manager, panels, views_content, panels_mini, panels_node, total_control, total_control_workflow, views_bonus_panels | |
| Page manager | 6.x-1.x-dev | Enabled | Ctools Chaos tool suite sites/default/modules/ctools/ | Provides a UI and API to manage pages within the site. | ctools_plugin_example, total_control, total_control_workflow | Chaos tools(enabled) |
| Views content panes | 6.x-1.x-dev | Enabled | Ctools Chaos tool suite sites/default/modules/ctools/ | Allows Views content to be used in Panels, Dashboard and other modules which use the CTools Content API. | total_control, total_control_workflow | Chaos tools(enabled), Views(enabled) |

Content Profile

| Name | Version | Status | Project / Package | Description | Required By | Depends On |
|----------------------|---------|---------|---|--|-------------|------------|
| Content Profile Page | 6.16 | Enabled | Content_profile_page Content Profile sites/default/modules/ | Integrates content profiles with user pages. | | |

| | | | | | | |
|---------------------------|-------------|---------|--|--------------------------------------|---|--|
| Content Profile (TFs mod) | 6.x-1.0-tfs | Enabled | Content_profile Content Profile sites/default/modules/ | Use content types for user profiles. | content_profile_page, content_profile_registration, content_profile_tokens | Content Profile (TFs mod) (enabled) |
|---------------------------|-------------|---------|--|--------------------------------------|---|--|

Content

| Name | Version | Status | Project / Package | Description | Required By | Depends On |
|--------------------|-------------|---------|--|--|---|--|
| Linktocontent | 6.x-2.x-dev | Enabled | Linktocontent Content sites/default/modules/ | Provides a small 'API' for FCKeditor and TinyMCE plugins to work with drupal data and functionality. | linktocontent_menu, linktocontent_node, linktocontent_category | |
| Linktocontent Menu | 6.x-2.x-dev | Enabled | Linktocontent Content sites/default/modules/linktocontent/contrib/ | Add links to menu items via a FCKeditor and TinyMCE plugin | | Linktocontent(enabled) |
| Linktocontent Node | 6.x-2.x-dev | Enabled | Linktocontent Content sites/default/modules/linktocontent/contrib/ | Add links to nodes via a FCKeditor and TinyMCE plugin | linktocontent_category | Linktocontent(enabled), Taxonomy(enabled) |

Core - optional

| Name | Version | Status | Project / Package | Description | Required By | Depends On |
|---------------------|---------|---------|---------------------------------------|---|---|------------------|
| Color | 6.16 | Enabled | Drupal Core - optional modules/ | Allows the user to change the color scheme of certain themes. | | |
| Comment | 6.16 | Enabled | Drupal Core - optional modules/ | Allows users to comment on and discuss published content. | forum, tracker | |
| Content translation | 6.16 | Enabled | Drupal Core - optional modules/ | Allows content to be translated into different languages. | i18n, i18n_test, i18npoll, translation_overview, i18nblocks, i18nccck, i18nmenu, i18nsync, i18ntaxonomy, i18nviews | Locale(enable d) |
| Database logging | 6.16 | Enabled | Drupal Core - optional modules/ | Logs and records system events to the database. | | |
| Help | 6.16 | Enabled | Drupal Core - optional modules/ | Manages the display of online help. | | |
| Locale | 6.16 | Enabled | Drupal Core - optional modules/ | Adds language handling functionality and enables the translation of the user interface to languages other than English. | date_locale, i18n, i18n_test, i18nstrings, languageicons, translation, translation_table, i18nblocks, i18nccck, i18ncontent, i18nmenu, i18npoll, i18nprofile, i18nsync, i18ntaxonomy, i18nviews, translation_overview | |
| Menu | 6.16 | Enabled | Drupal Core - optional modules/ | Allows administrators to customize the site navigation menu. | devel, i18nmenu, menu_block, menu_breadcrumb, menu_trails, nice_menus, og_menu | |
| PHP filter | 6.16 | Enabled | Drupal Core - optional modules/ | Allows embedded PHP code/snippets to be evaluated. | | |
| Path | 6.16 | Enabled | Drupal Core - optional modules/ | Allows users to rename URLs. | globalredirect, pathauto | |
| Poll | 6.16 | Enabled | Drupal Core - optional modules/ | Allows your site to capture votes on different topics in the form of multiple choice questions. | i18npoll | |
| Search | 6.16 | Enabled | Drupal Core - optional modules/ | Enables site-wide keyword searching. | search404, search_config, search_files, search_files_attachments, search_files_directories | |
| Statistics | 6.16 | Enabled | Drupal Core - optional modules/ | Logs access statistics for your site. | graphstat | |
| Taxonomy | 6.16 | Enabled | Drupal Core - optional modules/ | Enables the categorization of content. | content_taxonomy, content_taxonomy_autocomplete, content_taxonomy_options, content_taxonomy_tree, forum, i18ntaxonomy, linktocontent_node, notifications_tags, tac_lite, taxonomy_delegate, taxonomy_hide, taxonomy_menu, taxonomy_menu_hierarchy, taxonomy_menu_path_custom, taxonomy_menu_vocabulary_path, taxonomy_xml, term_permissions, xmlsitemap_taxonomy, i18nviews, linktocontent_category | |
| Trigger | 6.16 | Enabled | Drupal Core - optional modules/ | Enables actions to be fired on certain system events, such as when new content is created. | | |

Core - required

| Name | Version | Status | Project / Package | Description | Required By | Depends On |
|------|---------|--------|-------------------|-------------|-------------|------------|
|------|---------|--------|-------------------|-------------|-------------|------------|

| | | | | | | |
|--------|------|---------|---------------------------------|--|------------|--|
| Block | 6.16 | Enabled | Drupal Core - required modules/ | Controls the boxes that are displayed around the main content. | menu_block | |
| Filter | 6.16 | Enabled | Drupal Core - required modules/ | Handles the filtering of content in preparation for display. | spanspan | |
| Node | 6.16 | Enabled | Drupal Core - required modules/ | Allows content to be submitted to the site and displayed on pages. | | |
| System | 6.16 | Enabled | Drupal Core - required modules/ | Handles general site configuration for administrators. | | |
| User | 6.16 | Enabled | Drupal Core - required modules/ | Manages the user registration and login system. | | |

Date/Time

| Name | Version | Status | Project / Package | Description | Required By | Depends On |
|---------------|---------|---------|--|---|--|--|
| Calendar | 6.x-2.2 | Enabled | Calendar Date/Time sites/default/modules/ | Views plugin to display views containing dates as Calendars. | calendar_ical, jcalendar | Views(enabled), Date API(enabled), Date Timezone(enabled) |
| Calendar iCal | 6.x-2.2 | Enabled | Calendar Date/Time sites/default/modules/calendar/ | Adds ical functionality to Calendar views. | | Views(enabled), Date API(enabled), Calendar(enabled), Date Timezone(enabled) |
| Date | 6.x-2.4 | Enabled | Date Date/Time sites/default/modules/date/ | Defines CCK date/time fields and widgets. | date_tools | Content(enabled), Date API(enabled), Date Timezone(enabled) |
| Date API | 6.x-2.4 | Enabled | Date Date/Time sites/default/modules/ | A Date API that can be used by other modules. | calendar, calendar_ical, date, date_locale, date_php4, date_popup, date_repeat, date_timezone, date_tools, jcalendar | |
| Date Popup | 6.x-2.4 | Enabled | Date Date/Time sites/default/modules/date/ | Enables jquery popup calendars and time entry widgets for selecting dates and times. | | Date API(enabled), Date Timezone(enabled) |
| Date Timezone | 6.x-2.4 | Enabled | Date Date/Time sites/default/modules/date/ | Needed when using Date API. Overrides site and user timezone handling to set timezone names instead of offsets. | calendar, date, date_popup, calendar_ical, date_tools, jcalendar | Date API(enabled) |

Development

| Name | Version | Status | Project / Package | Description | Required By | Depends On |
|-------|----------|---------|--|--|-------------|---------------|
| Devel | 6.x-1.19 | Enabled | Devel Development sites/default/modules/ | Various blocks, pages, and functions for developers. | | Menu(enabled) |

Input filters

| Name | Version | Status | Project / Package | Description | Required By | Depends On |
|----------|---------|---------|---|--|-------------|-----------------|
| SpamSpan | 6.x-1.4 | Enabled | Spamspan Input filters sites/default/modules/ | The SpamSpan module obfuscates email addresses to help prevent spambots from collecting them. It implements the technique at http://www.spamspan.com . | | Filter(enabled) |

LDAP integration

| Name | Version | Status | Project / Package | Description | Required By | Depends On |
|----------------|---------------|---------|--|---|----------------------|-------------------------|
| Authentication | 6.x-1.0-beta1 | Enabled | Ldap_integration LDAP integration sites/default/modules/ | Implements LDAP authentication. | ldapdata, ldapgroups | |
| Groups | 6.x-1.0-beta1 | Enabled | Ldap_integration LDAP integration sites/default/modules/ | Implements LDAP groups to Drupal roles mapping. | | Authentication(enabled) |

Media

| Name | Version | Status | Project / Package | Description | Required By | Depends On |
|------|---------|--------|-------------------|-------------|-------------|------------|
|------|---------|--------|-------------------|-------------|-------------|------------|

| | | | | | | |
|---|-----------------|---------|--|--|--|--|
| Gallery Assist for the Cooliris Viewer | 6.x-1.x-dev | Enabled | Gallery_assist_4viewer Media sites/default/modules/ | Implement Cooliris in a gallery from Gallery Assist or Assignments. | | Gallery Assist (TFs mod) (enabled) |
| Gallery Assist Lightboxes (TFs mod) | 6.x-1.x-dev | Enabled | Gallery_assist_lightboxes Media sites/default/modules/ | Allow Gallery Assist to apply lightboxes. | | Gallery Assist (TFs mod) (enabled) |
| Gallery Assist Upload and Import helper (TFs mod) | 6.x-1.x-dev-tfs | Enabled | Gallery_assist_upload Media sites/default/modules/ | Extend Gallery Assist with import and upload functionalities. | | Gallery Assist (TFs mod) (enabled) |
| Gallery Assist Views | 6.x-1.x-dev | Enabled | Gallery_assist_views Media sites/default/modules/ | Allow to manipulate the data of Gallery Assist through the module Views. | | Gallery Assist (TFs mod) (enabled), Views(enabled) |
| Gallery Assist (TFs mod) | | Enabled | Gallery_assist Media sites/default/modules/ | Drupal content type with gallery functionality. | gallery_assist_4viewer, gallery_assist_lightboxes, gallery_assist_upload, gallery_assist_views, image_fupload_gallery_assist | |

Messaging

| Name | Version | Status | Project / Package | Description | Required By | Depends On |
|------------------|---------|---------|--|---|---|--------------------|
| Messaging | 6.x-2.2 | Enabled | Messaging Messaging sites/default/modules/ | Messaging system. This is the base module for the Messaging Framework | messaging_debug, messaging_mail, messaging_mime_mail, messaging_phpmailer, messaging_privatemsg, messaging_simple, messaging_sms, messaging_twitter, messaging_xmpp, notifications, og_notifications, notifications_autosubscribe, notifications_content, notifications_tags, notifications_ui, notifications_views | |
| Simple Mail | 6.x-2.2 | Enabled | Messaging Messaging sites/default/modules/messaging/ | Mail Sending Method: Integration with Drupal mail API | | Messaging(enabled) |
| Simple messaging | 6.x-2.2 | Enabled | Messaging Messaging sites/default/modules/messaging/ | Sending Method: Show messages on user's page | | Messaging(enabled) |

Multilanguage

| Name | Version | Status | Project / Package | Description | Required By | Depends On |
|--------------------------|---------|---------|--|---|--|--|
| Block translation | 6.x-1.4 | Enabled | i18n Multilanguage sites/default/modules/i18n/ | Enables multilingual blocks and block translation. | i18nmenu | Internationalization(enabled), String translation(enabled), Locale(enabled), Content translation(enabled) |
| CCK translation | 6.x-1.4 | Enabled | i18n Multilanguage sites/default/modules/i18n/ | Supports translatable custom CCK fields and fieldgroups. | | Internationalization(enabled), Content(enabled), String translation(enabled), Locale(enabled), Content translation(enabled) |
| Content type translation | 6.x-1.4 | Enabled | i18n Multilanguage sites/default/modules/i18n/ | Add multilingual options for content and translate related strings: name, description, help text... | | String translation(enabled), Locale(enabled) |
| Internationalization | 6.x-1.4 | Enabled | i18n Multilanguage sites/default/modules/ | Extends Drupal support for multilingual features. | i18n_test, i18nblocks, i18nck, i18nmenu, i18nsync, i18ntaxonomy, i18nviews | Locale(enabled), Content translation(enabled) |
| Menu translation | 6.x-1.4 | Enabled | i18n Multilanguage sites/default/modules/i18n/ | Supports translatable custom menu items. | | Internationalization(enabled), Menu(enabled), Block translation(enabled), String translation(enabled), Locale(enabled), Content translation(enabled) |
| Poll aggregate | 6.x-1.4 | Enabled | i18n Multilanguage sites/default/modules/i18n/ | Aggregates poll results for all translations. | | Content translation(enabled), Poll(enabled), Locale(enabled) |
| String translation | 6.x-1.4 | Enabled | i18n Multilanguage sites/default/modules/i18n/ | Provides support for translation of user defined strings. | i18nblocks, i18nck, i18ncontent, i18nmenu, i18nprofile, i18ntaxonomy, i18nviews, translation_table | Locale(enabled) |
| Synchronize translations | 6.x-1.4 | Enabled | i18n Multilanguage sites/default/modules/i18n/ | Synchronizes taxonomy and fields across translations of the same content. | | Internationalization(enabled), Locale(enabled), Content translation(enabled) |

| | | | | | | |
|----------------------|-------------|---------|--|--|-----------|---|
| Taxonomy translation | 6.x-1.4 | Enabled | l18n Multilanguage sites/default/modules/ /l18n/ | Enables multilingual taxonomy. | l18nviews | Internationalization(enabled), Taxonomy(enabled), String translation(enabled), Locale(enabled), Content translation(enabled) |
| Views translation | 6.x-1.4 | Enabled | l18n Multilanguage sites/default/modules/ /l18n/ | Translation of views strings and content selection for views. Requires Views 3.x | | Views(enabled), String translation(enabled), Taxonomy translation(enabled), Locale(enabled), Internationalization(enabled), Taxonomy(enabled), Content translation(enabled) |
| Language icons | 6.x-2.0 | Enabled | Languageicons Multilanguage sites/default/modules/ / | Adds icons to language links. | | Locale(enabled) |
| Translation overview | 6.x-2.4 | Enabled | Translation_overview Multilanguage sites/default/modules/ / | Provides an overview of the translation status of the site's content. | | Content translation(enabled), Locale(enabled) |
| Translation table | 6.x-1.x-dev | Enabled | Translation_table Multilanguage sites/default/modules/ / | UI for quick translation of dynamic strings. | | Locale(enabled), String translation(enabled) |

Notifications

| Name | Version | Status | Project / Package | Description | Required By | Depends On |
|------------------------|---------|---------|--|---|---|---|
| Content Notifications | 6.x-2.2 | Enabled | Notifications Notifications sites/default/modules/ notifications/ | Allows users to subscribe to content related events. | notifications_autosubscribe, notifications_tags, og_notifications | Notifications(enabled), Messaging(enabled), Token(enabled) |
| Notifications | 6.x-2.2 | Enabled | Notifications Notifications sites/default/modules/ | The basic notifications framework | notifications_autosubscribe, notifications_content, notifications_ui, notifications_views, og_notifications, notifications_tags | Messaging(enabled), Token(enabled) |
| Notifications Lite | 6.x-2.2 | Enabled | Notifications Notifications sites/default/modules/ notifications/ | Extra Simple Notifications API. Enable only when required by other modules. | og_notifications | |
| Notifications UI | 6.x-2.2 | Enabled | Notifications Notifications sites/default/modules/ notifications/ | Provides an UI to notifications | | Notifications(enabled), Messaging(enabled), Token(enabled) |
| Notifications Views | 6.x-2.2 | Enabled | Notifications Notifications sites/default/modules/ notifications/ | Views integration for Notifications. | | Views(enabled), Notifications(enabled), Messaging(enabled), Token(enabled) |
| Taxonomy Notifications | 6.x-2.2 | Enabled | Notifications Notifications sites/default/modules/ notifications/ | Allows users to subscribe to taxonomy terms. | | Content Notifications(enabled), Taxonomy(enabled), Notifications(enabled), Messaging(enabled), Token(enabled) |

Organic groups (TFS mod)

| Name | Version | Status | Project / Package | Description | Required By | Depends On |
|----------------|---------------|---------|---|---|--|------------|
| Organic groups | 6.x-2.1-patch | Enabled | Og Organic groups (TFS mod) sites/default/module s/ | Enable users to create and manage groups. OG Views integration module is recommended for best experience. | groupadmin, og_access, og_actions, og_description_droppper, og_menu, og_notifications, og_views, groupadmin_cp, groupadmin_profile | |

Organic groups

| Name | Version | Status | Project / Package | Description | Required By | Depends On |
|----------------------------------|-------------|---------|---|--|-----------------------------------|--|
| Group Admin | 6.x-2.1 | Enabled | Groupadmin Organic groups sites/default/modules/ | Provides a simple administrative interface to manage membership of OG Groups | groupadmin_cp, groupadmin_profile | Organic groups(enabled) |
| OG Menu (TFS mod) | 6.x-2.0-tfs | Enabled | Og_menu Organic groups sites/default/modules/ | Allow group creators and site admins to edit their own group menu. TFS Panels FIX. | | Menu(enabled), Organic groups(enabled) |
| Organic Groups Notifications | 6.x-2.1 | Enabled | Og Organic groups sites/default/modules/ og/modules/ | Allows users to receive notifications and subscribe to group content. | | Organic groups(enabled), Notifications(enabled), Content Notifications(enabled), Notifications Lite(enabled), Messaging(enabled), Token(enabled) |
| Organic groups Views integration | 6.x-2.1 | Enabled | Og Organic groups sites/default/modules/ og/modules/ | Highly recommended. Use Views to search and display organic groups. | | Organic groups(enabled), Views(enabled) |

| | | | | | | |
|------------------------|---------|---------|---|---|--|-------------------------|
| Organic groups actions | 6.x-2.1 | Enabled | Og Organic groups sites/default/modules/og/modules/ | Provides actions for use with Organic Groups and Trigger. | | Organic groups(enabled) |
|------------------------|---------|---------|---|---|--|-------------------------|

Other

| Name | Version | Status | Project / Package | Description | Required By | Depends On |
|--------------------------|-------------------|---------|---|--|---|-----------------------------|
| Advanced help | 6.x-1.2 | Enabled | Advanced_help Other sites/default/modules/ | Allow advanced help and documentation. | ctools_plugin_example, help_example | |
| Backup and Migrate Files | 6.x-1.x-dev | Enabled | Backup_migrate_files Other sites/default/modules/ | Add file backup and restore support to backup and migrate. | | Backup and Migrate(enabled) |
| Backup and Migrate | 6.x-2.x-dev | Enabled | Backup_migrate Other sites/default/modules/ | Backup or migrate the Drupal Database quickly and without unnecessary data. | backup_migrate_files | |
| Better Formats | 6.x-1.2 | Enabled | Better_formats Other sites/default/modules/ | Enhances the core input format system by managing input format defaults and settings. | | |
| Browscap | 6.x-1.1 | Enabled | Browscap Other sites/default/modules/ | Provides statistics on browsers and a replacement for PHP's get_browser() function. | | |
| Cache Exclude | 6.x-2.1 | Enabled | Cacheexclude Other sites/default/modules/ | Exclude certain pages from being cached. | | |
| DB Maintenance | 6.x-1.2 | Enabled | Db_maintenance Other sites/default/modules/ | Executes an OPTIMIZE TABLE query on MyISAM, InnoDB, or BerkeleyDB database tables in a MySQL database. | | |
| Delete orphaned terms | 6.x-1.x-dev | Enabled | Delete_orphaned_terms Other sites/default/modules/ | Delete orphaned taxonomy terms (ie, terms with no nodes associated with them). | | |
| Diff | 6.x-2.1-alpha3 | Enabled | Diff Other sites/default/modules/ | Show difference between node revisions. | | |
| FCKeditor | 6.x-1.4-rc2 | Enabled | Fckeditor Other sites/default/modules/ | Enables the usage of FCKeditor (WYSIWYG) instead of plain text fields. | | |
| Format Number API | 6.x-1.6 | Enabled | Format_number Other sites/default/modules/ | This module provides a method to configure number formats (site default and user defined) with configurable decimal point and thousand separators. It also exposes several functions that can be used by other contributed or custom modules to display numbers accordingly. | cache_browser | |
| Global Redirect | 6.x-1.x-dev | Enabled | Globalredirect Other sites/default/modules/ | Searches for an alias of the current URL and 301 redirects if found. Stops duplicate content arising when path module is enabled. | | Path(enabled) |
| Graphstat | 6.x-1.x-dev | Enabled | Graphstat Other sites/default/modules/ | Creates graphs visualizing statistical data of your site. | | Statistics(enabled) |
| Iconizer | 6.x-1.x-dev | Enabled | Iconizer Other sites/default/modules/ | Adds icons next to links in Admin-section, well-know protocols and files links. | | |
| Image FUpload | 6.x-3.0-rc2-patch | Enabled | Image_fupload Other sites/default/modules/ | Allows uploading several images all at once using swfUpload | image_fupload_gallery_assist, image_fupload_image, image_fupload_imagefield | |
| IMCE Crop | 6.x-1.0 | Enabled | Imce_crop Other sites/default/modules/ | Adds image cropping functionality to IMCE | | IMCE(enabled) |

| | | | | | | |
|---------------------------|----------------|---------|---|--|--|--|
| IMCE Mkdir | 6.x-1.0 | Enabled | Imce_mkdir Other sites/default/modules/ | Allows users manage directories in IMCE | | IMCE(enabled) |
| Imce_watermark | 6.x-1.x-dev | Enabled | Imce_watermark Other sites/default/modules/ | Watermarking images downloaded by imce. | | IMCE(enabled) |
| IMCE | 6.x-1.3 | Enabled | Imce Other sites/default/modules/ | An image/file uploader and browser supporting personal directories and user quota. | imce_crop, imce_mkdir, imce_watermark, imcefile, imceimage | |
| Integrated Metatags | 6.x-1.0-beta7 | Enabled | Int_meta Other sites/default/modules/ | Provides functionality for modules to dynamically add Metatags. | int_meta_cck | |
| Integrated Metatags - CCK | 6.x-1.0-beta7 | Enabled | Int_meta Other sites/default/modules/ | Adds Integrated Metatag functionality to CCK types and fields. | | Integrated Metatags(enabled), Content(enabled) |
| Libraries | 6.x-1.0-alpha1 | Enabled | Libraries Other sites/default/modules/ | External library handling for Drupal modules. | | |
| Lightbox2 | 6.x-1.9 | Enabled | Lightbox2 Other sites/default/modules/ | Enables Lightbox2 for Drupal | | |
| Login destination | 6.x-2.10 | Enabled | Login_destination Other sites/default/modules/ | Control where users are directed to once they login. | | |
| Masquerade | 6.x-1.3 | Enabled | Masquerade Other sites/default/modules/ | This module allows permitted users to masquerade as other users. | | |
| Menu Block | 6.x-2.3 | Enabled | Menu_block Other sites/default/modules/ | Provides configurable blocks of menu items. | | Block(enabled), Menu(enabled) |
| Menu breadcrumb | 6.x-1.x-dev | Enabled | Menu_breadcrumb Other sites/default/modules/ | Allows you to use the menu the current page belongs to for the breadcrumb. | | Menu(enabled) |
| Nodeaccess | 6.x-1.3 | Enabled | Nodeaccess Other sites/default/modules/ | Provides per node access control | | |
| Override node options | 6.x-1.10 | Enabled | Override_node_options Other sites/default/modules/ | Allow non-admins to override the default publishing options for nodes they can edit. | | |
| Pagination | 6.x-1.6 | Enabled | Pagination Other sites/default/modules/ | Allows arbitrary nodes to be paginated based on automatic or manual paging | | |
| Password policy | 6.x-1.0-alpha2 | Enabled | Password_policy Other sites/default/modules/ | The password policy module allows you to enforce a specific level of password complexity for the user passwords on the system. | password_policy_password_tab | |
| Path redirect | 6.x-1.0-beta6 | Enabled | Path_redirect Other sites/default/modules/ | Redirect users from one URL to another. | path_redirect_generate | |
| Pathauto | 6.x-1.3 | Enabled | Pathauto Other sites/default/modules/ | Provides a mechanism for modules to automatically generate aliases for the content they manage. | | Path(enabled), Token(enabled) |
| RealName | 6.x-1.3 | Enabled | Realname Other sites/default/modules/ | Use user profile fields to build a 'realname' field in a user object. | | |
| Revision Deletion | 6.x-1.0-rc2 | Enabled | Revision_deletion Other sites/default/modules/ | Enables the ability to mass delete aging node revisions. | | |

| | | | | | | |
|-------------------------------------|-------------|---------|--|---|---|-------------------|
| | | | s/ | | | |
| Role Delegation | 6.x-1.3 | Enabled | Role_delegation Other sites/default/module s/ | Allows site administrators to grant some roles the authority to assign selected roles to users. | | |
| Scheduler | 6.x-1.6 | Enabled | Scheduler Other sites/default/module s/ | This module allows nodes to be published and unpublished on specified dates. | | |
| Search 404 | 6.x-1.9 | Enabled | Search404 Other sites/default/module s/ | Search 404 | | Search(enabled) |
| Search config | 6.x-1.5 | Enabled | Search_config Other sites/default/module s/ | Configure display of the advanced search form | | Search(enabled) |
| Site map | 6.x-1.2 | Enabled | Site_map Other sites/default/module s/ | Display a site map. | | |
| Site Documentation | 6.x-1.2 | Enabled | Sitedoc Other sites/default/module s/ | Displays various pieces of information about this Drupal installation. | | |
| String Overrides | 6.x-1.7 | Enabled | Stringoverrides Other sites/default/module s/ | Provides a quick and easy way of replacing text. | | |
| Taxonomy Access Control Life | 6.x-1.3 | Enabled | Tac_lite Other sites/default/module s/ | Simple access control based on categories. | | Taxonomy(enabled) |
| Taxonomy Delegate | 6.x-1.3 | Enabled | Taxonomy_delegate Other sites/default/module s/ | Allows delegating vocabulary maintenance. | | Taxonomy(enabled) |
| Taxonomy hide | 6.x-1.02 | Enabled | Taxonomy_hide Other sites/default/module s/ | Hides and groups vocabulary terms in node views. | | Taxonomy(enabled) |
| Taxonomy Term Permissions (TFs mod) | 6.x-1.0-tfs | Enabled | Term_permissions Other sites/default/module s/ | Allows limiting the selection of specific taxonomy terms by user or role. | | Taxonomy(enabled) |
| Token | 6.x-1.12 | Enabled | Token Other sites/default/module s/ | Provides a shared API for replacement of textual placeholders with actual data. | content_profile_tokens, notifications, og_notifications, pathauto, tokenSTARTER, token_actions, notifications_autosubscribe, notifications_content, notifications_tags, notifications_ui, notifications_views | |
| Transliteration | 6.x-2.1 | Enabled | Transliteration Other sites/default/module s/ | Provides transliteration for UTF-8 text input and sanitizes file names. | | |
| Userplus | 6.x-2.4 | Enabled | Userplus Other sites/default/module s/ | The userplus module provides enhanced user administration features. | | |
| Vocabulary Permissions | 6.x-1.1 | Enabled | Vocabperms Other sites/default/module s/ | set access to taxonomy vocabulary node information by role | | |
| Webform (TFs mod) | 6.x-2.9-tfs | Enabled | Webform Other sites/default/module s/ | Enables the creation of forms and questionnaires. | | |

Panels

| Name | Version | Status | Project / Package | Description | Required By | Depends On |
|-------------|---------|---------|--|---|-------------|---------------------------------------|
| Mini panels | 6.x-3.3 | Enabled | Panels Panels sites/default/modules/panels/ | Create mini panels that can be used as blocks by Drupal and panes by other panel modules. | | Panels(enabled), Chaos tools(enabled) |

| | | | | | | |
|-------------|---------|---------|---|---|--|---------------------------------------|
| Panel nodes | 6.x-3.3 | Enabled | Panels Panels sites/default/modules/ panels/ | Create nodes that are divided into areas with selectable content. | | Panels(enabled), Chaos tools(enabled) |
| Panels | 6.x-3.3 | Enabled | Panels Panels sites/default/modules/ | Core Panels display functions; provides no external UI, at least one other Panels module should be enabled. | ctools_plugin_example, panels_mini, panels_node, total_control, views_bonus_panels, total_control_workflow | Chaos tools(enabled) |

Search

| Name | Version | Status | Project / Package | Description | Required By | Depends On |
|-----------------------------|---------------|---------|--|---|---|---|
| Porter Stemmer | 6.x-2.5 | Enabled | Porterstemmer Search sites/default/modules/ / | Improve English language searching by simplifying related words to their root (conjugations, plurals, ...). | | |
| Search Files API (TFs mod) | 6.x-2.0-beta4 | Enabled | Search_files Search sites/default/modules/ / | API for indexing and searching files | search_files_attachments, search_files_directories | Search(enabled) |
| Search Files in Directories | 6.x-2.0-beta4 | Enabled | Search_files Search sites/default/modules/ / | Search files and their content in directories | | Search Files API (TFs mod) (enabled), Search(enabled) |

Spam control

| Name | Version | Status | Project / Package | Description | Required By | Depends On |
|---------------|---------|---------|---|---|---------------|------------------|
| CAPTCHA | 6.x-2.1 | Enabled | Captcha Spam control sites/default/modules/ | Base CAPTCHA module for adding challenges to arbitrary forms. | image_captcha | |
| Image CAPTCHA | 6.x-2.1 | Enabled | Captcha Spam control sites/default/modules/captcha/ | Provides an image based CAPTCHA. | | CAPTCHA(enabled) |

Statistics

| Name | Version | Status | Project / Package | Description | Required By | Depends On |
|------------------|---------|---------|--|--|-------------|------------|
| Google Analytics | 6.x-2.2 | Enabled | Google_analytics Statistics sites/default/modules/ | Adds Google Analytics javascript tracking code to all your site's pages. | | |

Taxonomy Menu

| Name | Version | Status | Project / Package | Description | Required By | Depends On |
|-------------------------------|-------------|---------|--|--|---|---|
| Taxonomy Menu (TFs mod) | 6.x-2.7-tfs | Enabled | Taxonomy_menu Taxonomy Menu sites/default/modules/ | Adds links to taxonomy terms to a menu. | taxonomy_menu_hierarchy, taxonomy_menu_path_custom, taxonomy_menu_vocabulary_path | Taxonomy(enabled) |
| Taxonomy Menu Hierarchy | 6.x-2.7 | Enabled | Taxonomy_menu Taxonomy Menu sites/default/modules/taxonomy_menu/ | Enables Hierarchy path to Taxonomy Menu. | | Taxonomy(enabled), Taxonomy Menu (TFs mod)(enabled) |
| Taxonomy Menu Vocabulary Path | 6.x-2.7 | Enabled | Taxonomy_menu Taxonomy Menu sites/default/modules/taxonomy_menu/ | Enables a custom path for each vocabulary through Taxonomy Menu. | | Taxonomy(enabled), Taxonomy Menu (TFs mod)(enabled) |

Taxonomy

| Name | Version | Status | Project / Package | Description | Required By | Depends On |
|--------------------------------|---------|---------|--|--|-------------|-------------------|
| Taxonomy Import/Export via XML | 6.x-1.3 | Enabled | Taxonomy_xml Taxonomy sites/default/modules/ | Makes it possible to import and export taxonomy terms via XML. | | Taxonomy(enabled) |

Theme

| Name | Version | Status | Project / Package | Description | Required By | Depends On |
|-------------------------------|-------------|---------|--|---|-------------|------------|
| Role Theme Switcher (TFs mod) | 6.x-1.5-tfs | Enabled | Role_theme_switcher Theme sites/default/modules/ | Assign separate themes to different roles | | |
| Theme Editor | 6.x-1.4 | Enabled | Theme_editor Theme sites/default/modules/ | Provides a Theme Editor Page similar to the Wordpress theme editor. | | |

User interface

| Name | Version | Status | Project / Package | Description | Required By | Depends On |
|---------------|-------------|---------|---|---|--|------------|
| jQuery UI | 6.x-1.3 | Enabled | Jquery_ui User interface sites/default/modules/ | Provides the jQuery UI plug-in to other Drupal modules. | form_builder, form_builder_examples, form_builder_node | |
| Vertical Tabs | 6.x-1.0-rc1 | Enabled | Vertical_tabs User interface sites/default/modules/ | Provides vertical tabs for supported forms like the node edit page. | | |

Util

| Name | Version | Status | Project / Package | Description | Required By | Depends On |
|---------------|---------|---------|--|---|--|---------------|
| System Module | 6.x-2.3 | Enabled | Util Util sites/default/modules/ | Set default collapsed/expanded state for system modules fieldsets | module_weights | Util(enabled) |
| Util | 6.x-2.3 | Enabled | Util Util sites/default/modules/ | Enables Menu parent for the util modules | module_weights, perms_fieldsets, system_module | |

Views

| Name | Version | Status | Project / Package | Description | Required By | Depends On |
|-------------------------------|-------------|---------|--|--|---|---|
| Insert view | 6.x-2.x-dev | Enabled | Insert_view Views sites/default/modules/ | Input filter which allows to embed views. | | Views(enabled) |
| Timeline (TFs mod) | 6.x-2.1 | Enabled | Timeline Views sites/default/modules/ | Provides a draggable and scrollable timeline view. Requires the views module and the libraries module and makes use of the cck and date module if available. | | Views(enabled) |
| Bonus: Panels | 6.x-1.0 | Enabled | Views_bonus Views sites/default/modules/views_bonus/ | Various views style plugins to put views nodes in panels | | Views(enabled), Panels(enabled), Chaos tools(enabled) |
| Bonus: Views Export | 6.x-1.0 | Enabled | Views_bonus Views sites/default/modules/views_bonus/ | Plugin to export views a couple of formats including Comma Separated Values(CSV), Doc or XML | | Views(enabled) |
| Views Bulk Operations | 6.x-1.9 | Enabled | Views_bulk_operations Views sites/default/modules/ | Exposes new Views style 'Bulk Operations' for selecting multiple nodes and applying operations on them. | total_control, total_control_workflow | Views(enabled) |
| Views Custom Field | 6.x-1.0 | Enabled | Views_customfield Views sites/default/modules/ | Provides a number of custom fields (rownumber, phpcode, ...). | | Views(enabled) |
| Views filter reset (TFs only) | 6.x-1.1-tfs | Enabled | Views_filter_reset Views sites/default/modules/ | Add Reset button to exposed views filter. | | Views(enabled) |
| Views Or | 6.x-1.x-dev | Enabled | Views_or Views sites/default/modules/ | Allows Views to combine filters or arguments with OR and fields with COALESCE. | | Views(enabled) |
| Views | 6.x-2.9 | Enabled | Views Views sites/default/modules/ | Create customized lists and queries from your database. | calendar, calendar_ical, gallery_assist_views, i18nviews, insert_view, jcalendar, notifications_views, og_views, timeline, viewreference, views_bonus_export, views_bonus_paged_feed, views_bonus_panels, views_bonus_spy, views_bulk_operations, views_content, views_customfield, views_export, views_filter_reset, views_or, views_ui, total_control, total_control_workflow | |
| Views UI | 6.x-2.9 | Enabled | Views Views sites/default/modules/ | Administrative interface to views. Without this module, you cannot create or edit your views. | | Views(enabled) |
| Views exporter | 6.x-2.9 | Enabled | Views Views sites/default/modules/views/ | Allows exporting multiple views at once. | | Views(enabled) |

XML sitemap

| Name | Version | Status | Project / Package | Description | Required By | Depends On |
|----------------------|---------|---------|--|---|---|--|
| XML sitemap | 6.x-1.2 | Enabled | Xmlsitemap XML sitemap sites/default/modules/ | Create a XML sitemap conforming to sitemaps.org specifications. | xmlsitemap_engines, xmlsitemap_node, xmlsitemap_taxonomy, xmlsitemap_user | |
| XML sitemap node | 6.x-1.2 | Enabled | Xmlsitemap XML sitemap sites/default/modules/xml sitemap/ | Add node links to the sitemap. | | XML sitemap(enabled) |
| XML sitemap taxonomy | 6.x-1.2 | Enabled | Xmlsitemap XML sitemap sites/default/modules/xml sitemap/ | Add taxonomy term links to the sitemap. | | Taxonomy(enabled), XML sitemap(enabled) |
| XML sitemap user | 6.x-1.2 | Enabled | Xmlsitemap XML sitemap sites/default/modules/xml sitemap/ | Add user profile links to the sitemap. | | XML sitemap(enabled) |

Příloha č. 4 (všechna schémata jsou k dispozici na přiloženém DVD)

Schéma vzájemných vztahů částí systému - uživatelské role a systém kontroly oprávnění



Schéma vzájemných vztahů částí systému - základní stavební součásti a přístup uživatelů



Schéma vzájemných vztahů částí systému - vzájemné relace mezi obsahovými typy, kategorizací a uživatelem

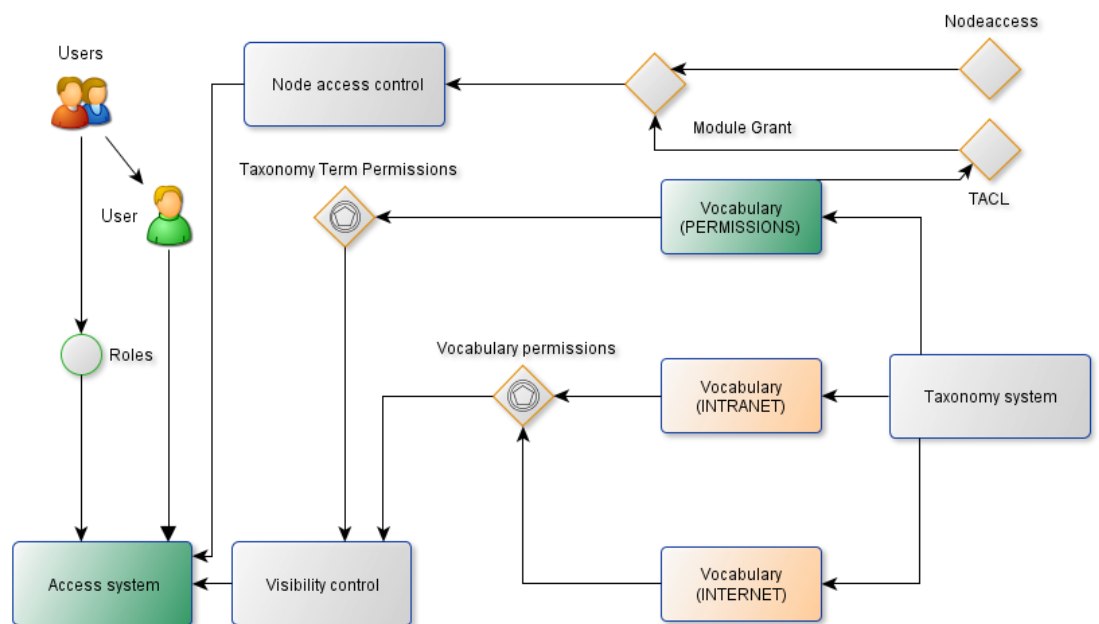
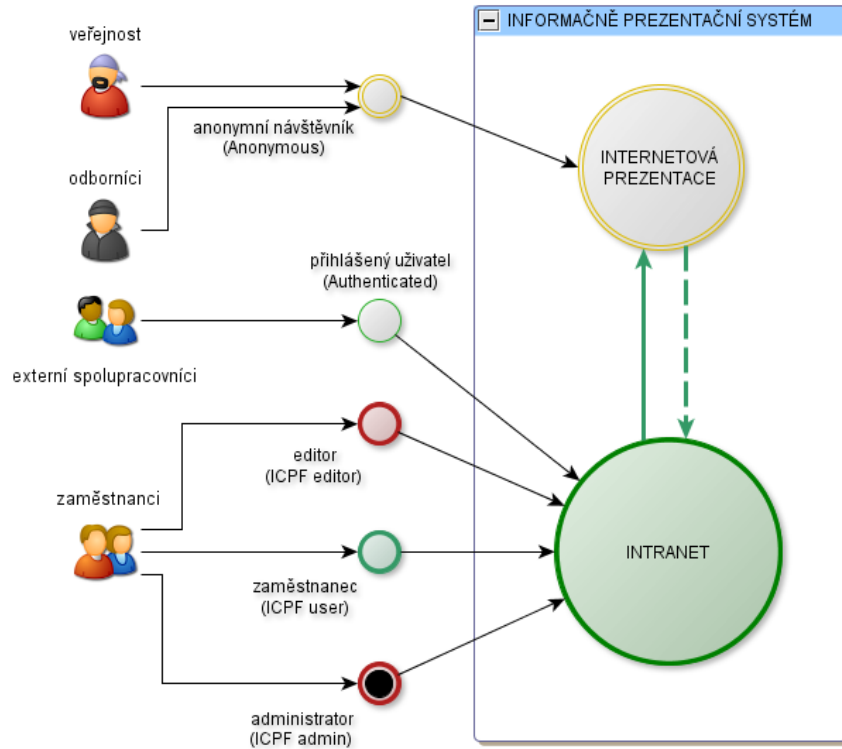

Příloha č. 5

Schéma uživatelských rolí a rozšířených datových struktur (obsahových typů)

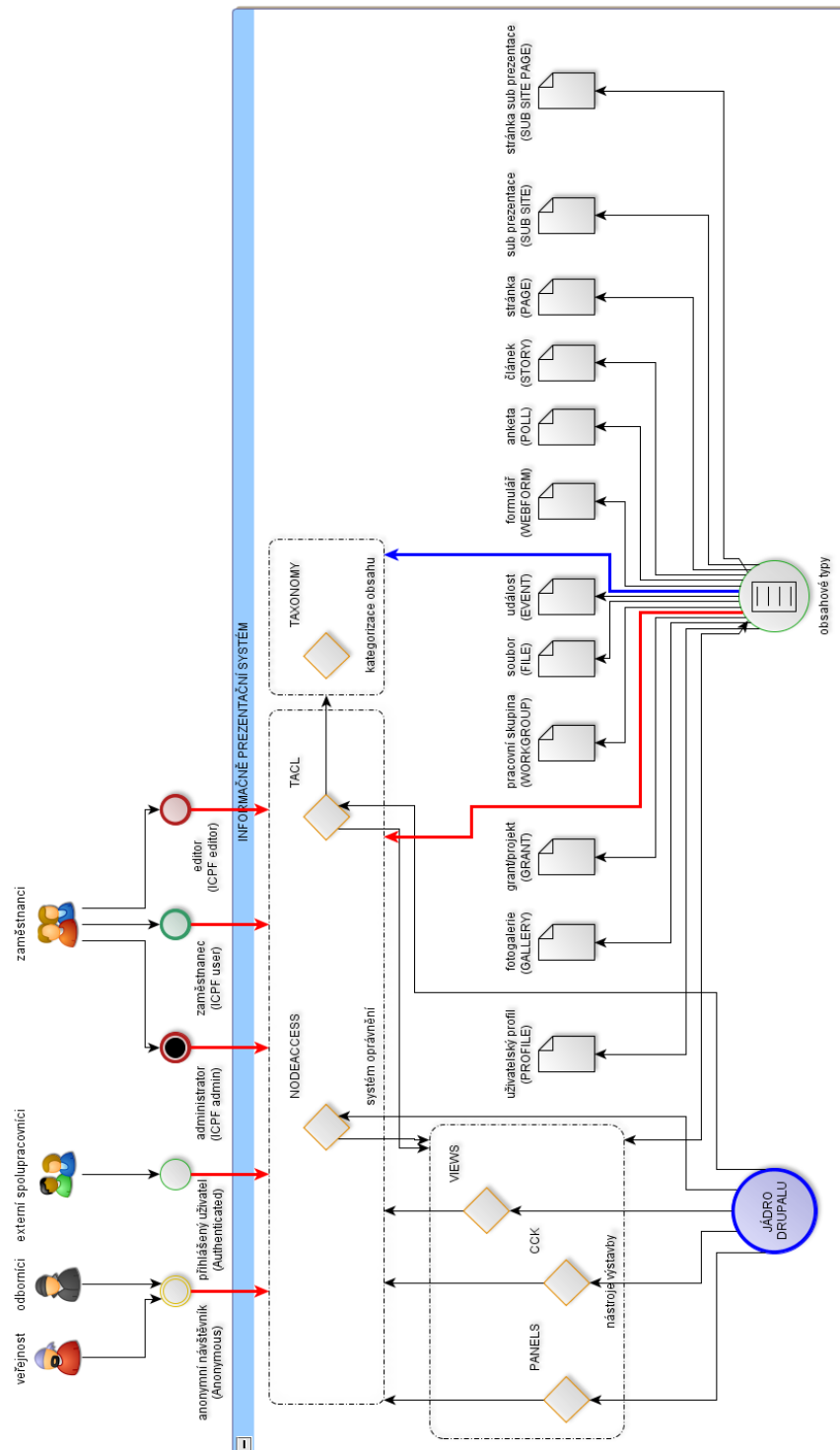
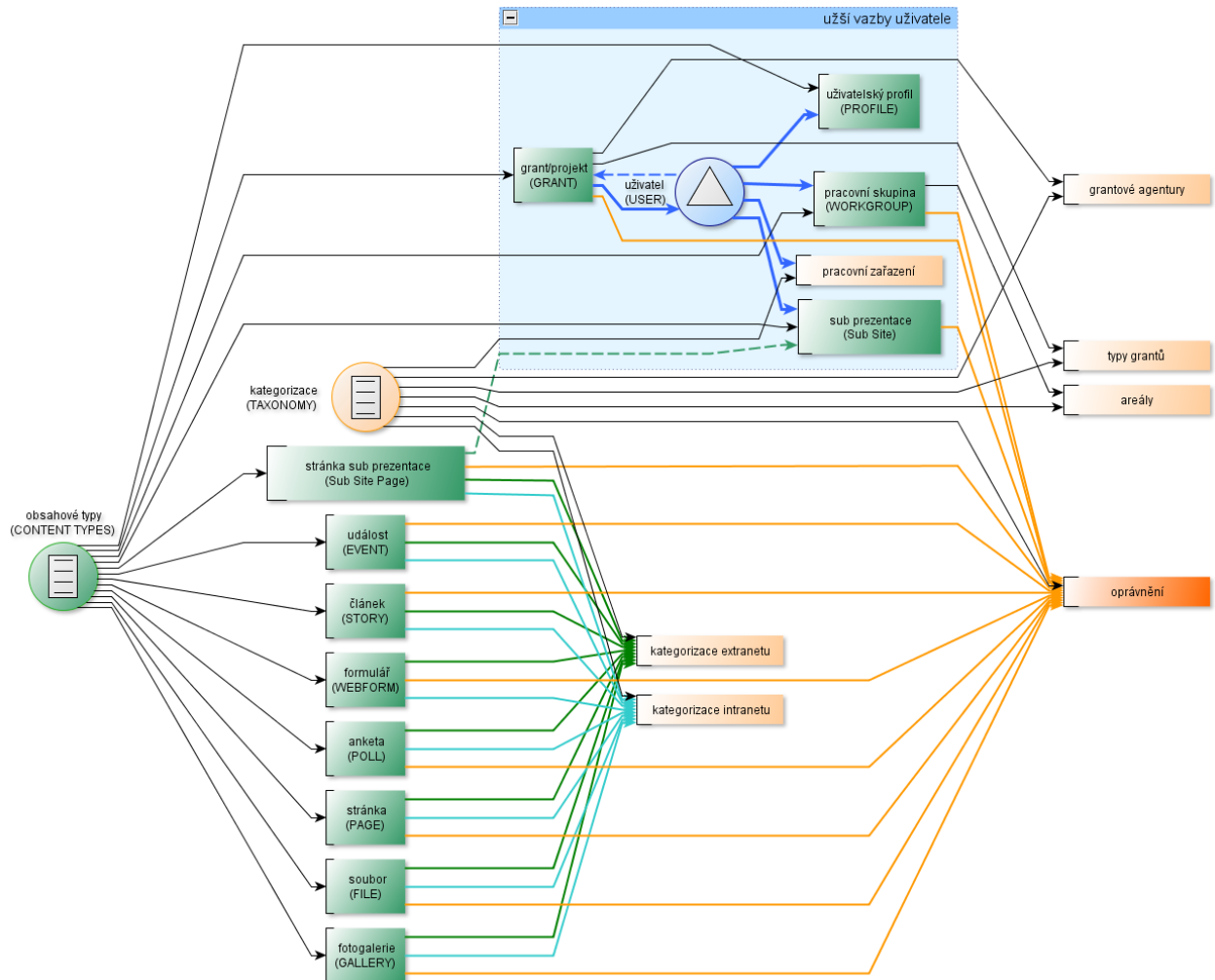